



FORD RANGER





TONNEAU COVER ALU

TONNEAU COVER ALUMINIUM SMOOTH

NO PAINT

Double CAB : EVO900P

Super CAB : EVO950P



- Installation without drilling
- Waterproof
- Load 100 kg on the cover
- 80 kg on the roof bars
- Quick disassembly



No DRILLING

Orange Pride

DC : EVO900S5FLQ

SC : EVO950S5FLQ

Lunar Gray

DC : EVO900SZJNC

SC : EVO950SZJNC

Basalt Gray

DC : EVO900S6DYE

SC : EVO950S6DYE

WILDTRACK

Glacier White

DC : EVO900S7VTA

SC : EVO950S7VTA

Black Shadow

DC : EVO900SG9ZE

SC : EVO950SG9ZE



Lunar Gray

DC : EVOR330-ZJNC

SC : EVOR350-ZJNC

Black Shadow

DC : EVOR330-G9ZE

SC : EVOR350-G9ZE

Ocean Blue

DC : EVOR330-6DVC

SC : EVOR350-6DVC

**WITH ORIGINAL
ROLL BAR**

Cyclone Blue

DC : EVOR330-3CVC

SC : EVOR350-3CVC

Copper Red

DC : EVOR330-37M

SC : EVOR350-37M

Gray Pearl

DC : EVOR330-2PNC

SC : EVOR350-2PNC



TONNEAU COVER ALU



TONNEAU COVER ALUMINIUM TREAD

W/O ROLL BAR



ALUMINIUM

BLACK

DC : EV0330

DC : EV0330B

SC : EV0350

SC : EV0350B



No DRILLING

WITH ORIGINAL
ROLL BAR



ALUMINIUM

BLACK

DC : EVOR330

DC : EVOR330B

SC : EVOR350

SC : EVOR350B

WILDTRACK



ALUMINIUM

BLACK

DC : EV0900S

DC : EV0900SB

SC : EV0950S

SC : EV0950SB

ROLL BAR

Roll Bar INOX : EVRLB76A-C1

Roll Bar BLACK : EVRLB76AB-C1





TONNEAU COVER

TONNEAU COVER

NO PAINT

DC : CT295

SC : CT297

W/O ROLL BAR



No DRILLING

NO PAINT

DC : CT296

SC : CT298

WITH ORIGINAL
ROLL BAR



NO PAINT

DC : CT299

SC : CT300

WILDTRACK



NO PAINT

DC : TCFORD.

+ ROLL BAR INOX

DC : TCFORD.B

+ BLACK ROLL BAR



ROLL TOP COVER



ROLL TOP COVER

- Secures your load

- Possibility to load parts without removing the cover



W/O ROLL BAR

DC : *RTC295*
SC : *RTC295K*



No DRILLING



WITH ORIGINAL
ROLL BAR

DC : *RTC295OEROLL*
SC : *RTC295KOE*



WILDTRACK

DC : *RTC293*



ROLL BAR

Roll Bar INOX : *RTCR2295B*
Roll Bar BLACK : *RTCR2295*

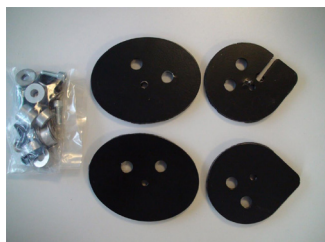

ROLL BAR MOUNTING KIT ON ROLL TOP COVER

Roll Bar INOX : *RTCR295OE*



SOFT TOP

SOFT TOP

- Easy and quick installation

DC : SFTC0028 - W/O Roll Bar

DC : SFTC0029 + Sport Bar

SC : SFTC0035 + Sport Bar



No DRILLING



ROLL BAR

INOX : SFTR330

BLACK : SFTR330B



TONNEAU COVER «TANGO»



TONNEAU COVER «TANGO»

Compatible with original ROLL BAR

NO PAINT / Double CAB

WITH central locking : TGTC295

WITHOUT central locking : TGT295

ROLL BAR (Option)

INOX : TGRLB295

NOIR : TGRLB295N

BED-RAIL PROTECTION

Ref : TGB295

SLIDING LOAD STOP

Double CAB : TGA450

ROOF BARS - 75 kg (Pair)

Ref : TGBA450

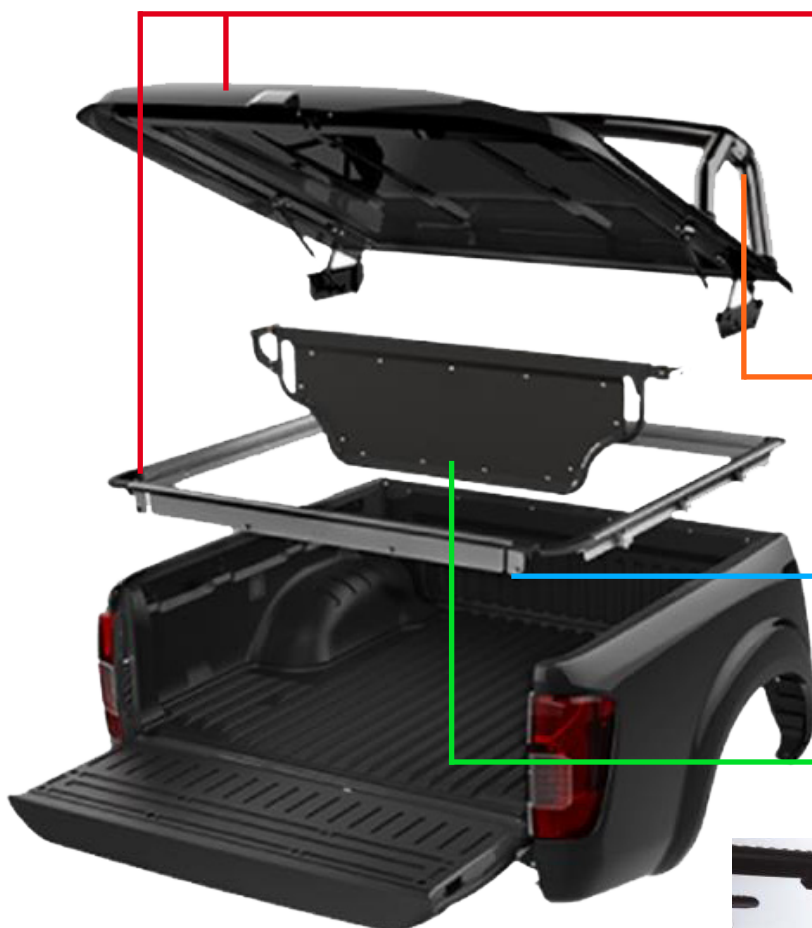



BULL BAR

FRONT PROTECTION



CE APPROVED

Sold with European homologation certificate
Standard 2005/66 / CE

MEDIUM BAR INOX - ø 63 mm

Ref : *ECMED295*

FORD RANGER 2012+

ADAPTIVE RADAR & CAMERA COMPATIBLE



MEDIUM BAR NOIR - ø 63 mm

Ref : *ECMED295N*

FORD RANGER 2012+

ADAPTIVE RADAR & CAMERA COMPATIBLE



SUPER BAR INOX - ø 76 mm

Ref : *ECSPB295*

FORD RANGER 2012+

ADAPTIVE RADAR & CAMERA COMPATIBLE



SUPER BAR INOX - ø 76 mm

Ref : *ECSPB295N*

FORD RANGER 2012+

ADAPTIVE RADAR & CAMERA COMPATIBLE



REAR PROTECTION

REAR BUMPER - ø 63 mm

Ref : *DBR330IX*

FORD RANGER 2012+

NOT APPROVED CE



SIDE STEP



SIDE STEP



OVAL DESIGN SIDE STEP TUBES

DC INOX : DSP295

DC NOIR : DSP295N

SC INOX : DSP330

SC NOIR : DSP330N



ROUND SIDE STEP TUBES Ø 76 MM

DC INOX : GP295

DC NOIR : GP295N

SC INOX : GP330

SC NOIR : GP330N



OVAL SIDE STEP TUBES Ø 76 MM

DC INOX : GPO295IX

DC NOIR : GPO295N

SC INOX : GPO330IX

SC NOIR : GPO330N



ROUND SIDE STEP TUBES Ø 50 MM

DC INOX : P295IX

DC NOIR : P295N

SC INOX : P330IX

SC NOIR : P330N



SIDE STEP INOX Ø 76 MM

DC & SC INOX : ME295



MOTORIZED SIDE STEP

DC & SC : AGG295

Automatically open and close at the OPENING and CLOSING of the doors.

Admissible weight: 300 KG



ROLL BAR

ROLL BAR

ROLL BAR INOX - DOUBLE TUBE Ø 76 MM

- BUCKET EDGE FIXING

BLACK : *RLSS2295N*

INOX : *RLSS2295IX*

INOX «With marking» : *RLSSK2295IX*



ROLL BAR INOX «New Style» - DOUBLE TUBE Ø 76 MM

BLACK : *R295*



ROLL BAR BLACK - DOUBLE TUBE Ø 76 MM

BLACK : *RLL295*



ROLL BAR INOX - TUBE Ø 76 MM «With grill»

BLACK : *ME296*



ROFF & TRUCK BED RACK



ROOF RACK



Roof rack kit (1255 x 1358 mm).

A drilling is necessary for the installation of the gallery

Ref : KRFM001T (DC) - LOW PROFILE

Ref : KRFM010T (DC) - HIGH PROFILE

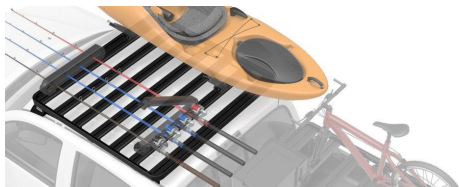

Roof rack kit (1255 x 1358 mm).

A drilling is necessary for the installation of the gallery

Ref : KRFM005T (DC & WILDTRACK)

Ref : KRFS004T (SC)



Roof rack kit (1255 x 1358 mm).

NO drilling required for the installation of the gallery

Ref : KRFR004T (WILDTRACK) Sur barre longitudinale



TRUCK BED RACK

Truck bed rack kit

A drilling is necessary for the installation of the gallery

Ref : KRLB002T (DC & SC) - 1358*1425

Ref : KRLB005T (DC & SC) - 1358*1475

Ref : KRRT016T (WILDTRACK) Comp. RollTop Origine



ROFF & TRUCK BED RACK

TOOL BOX



Ref : **BOX2** (1400 x 540 x 540)



Ref : **BOX1** (1320 x 505 x 475)



Ref : **BOX5** (1400 x 552 x 527)



Ref : **BOX4** (1580 x 650 x 466) - Butterfly opening

DRAWER KIT

*Drawer kit specially designed for the Ford Ranger (DC)
Double lockable drawer.*

Ref : **SSFR001**

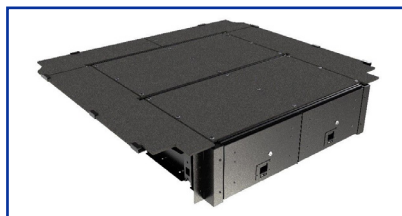

*Drawer kit specially designed for the Ford Ranger (DC)
Single lockable drawer. 6x Wolf Packs (Option)*

Ref : **SWFR001**



*«Universal» drawer kit
Single lockable drawer. 6x Cub Pack (Option)*

Ref : **SSTH012** (ALL MODELS)



STORAGE SYSTEM



DECKED

- WATERPROOF
- LOAD 900 KG ON THE TRAY
- LOAD 100 KG EACH DRAWER

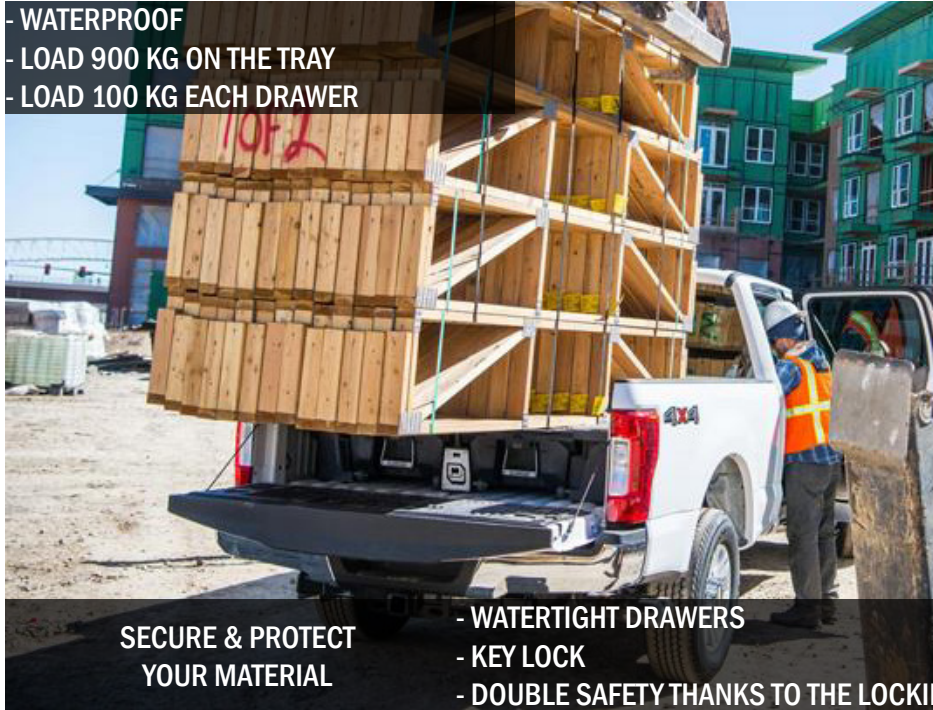

SECURE & PROTECT
YOUR MATERIAL

- WATERTIGHT DRAWERS
- KEY LOCK
- DOUBLE SAFETY THANKS TO THE LOCKING OF THE TAILGATE

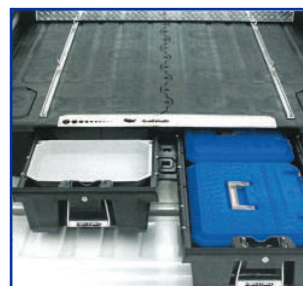
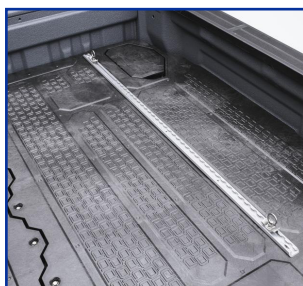

ALUMINUM RAIL (OPTION)

The aluminum rails allow you to secure your load.

SEALING

This material is waterproof *
Designed to withstand bad weather and UV. They will withstand the largest temperature variations.

PLATFORM

Raised platform above the wheel arches, real payload of 900KG. Customizable storage thanks to the accessories.



STORAGE SYSTEM

BEDSLIDE - Sliding tray

Ref : BEDSLIDE6

COMPATIBLE DOUBLE, EXTRA & SIMPLE CAB

BEDSLIDE delivered in a length of 1443 mm (standard & double cab). The tray can be deployed up to a length of 1843mm. so it adjusts to double, extra & single cabin.



BUCKET TAIL SHOCK ABSORBER

Ref : EZUP295

Assists **DESCENT** and **ASCENT**



BUCKET TAIL SHOCK ABSORBER

Ref : EZ295

Assists only the **DESCENT**



CENTRALIZED HATCHBACK CLOSING SYSTEM

Ref : FC295



DUMP TRUCK SEAL KIT

Ref : SKJ295



HARD TOP



Made of reinforced fiberglass, with polyurethane door,
Stainless steel lock system.
Easy assembly and without perforation.
Possible options:
With or without windows
With or without side doors
Left OR Right door (on some models)

HARD TOP
EUROPEAN MANUFACTURING



No DRILLING

HARD TOP with window

Ref : 41.FR5 136

DOUBLE CABINE



HARD TOP W/O window

DOUBLE CABINE

Ref : 41.FR5 137



HARD TOP with doors

Ref : 41.FR5 620

EXTRA CABINE



HARD TOP W/O doors

DOUBLE CABINE

Ref : 41.FR5 610



* Other models available, contact us for more information.



HARD TOP

HARD TOP - EXPLORER 3

Double CAB / Extra CAB / Simple CAB

Characteristics :

- Full width window
- Black or Gray
- Smooth or streaked
- Equipped with front and rear glass in safety glass
- Interior LED light preinstalled
- Two roof rails allow the installation of roof racks or the like.
- All doors are lockable
- EPOXY paint
- Weight: about 57 KG



LÉGER, ROBUSTE ET DURABLE !



POIGNEE ARRIÈRE



VERROUILLAGE



RAIL DE TOIT



JOINT FLEX

HARD TOP - ADVENTURE 3

Double CAB / Extra CAB / Simple CAB



Characteristics :

- 900 mm wide window, it allows the installation of a ladder, a canister door or a gas bottle holder at the back of the hardtop
- Black or Gray
- Smooth or streaked
- Equipped with front and rear glass in safety glass
- Interior LED light preinstalled
- Two roof rails allow the installation of roof racks or the like.
- All doors are lockable
- EPOXY paint
- Weight: about 57 KG



ALUMINIUM BUMPER



FRONT BUMPER - Aluminium 6 mm

2015 - 2018 / SANS LEDS : RI2D.1808.1-NL

CE APPROVED LED OPTION : DURA-E4M + P-DURA4FLUSHM

OPTION LED WORK : DURA-410 + P-DURA4FLUSHM



NOT APPROVED CE



REAR BUMPER - Aluminium 4 mm

SANS LEDS : RI2D.1811.1-NL

CE APPROVED LED OPTION : DURA-E4M + P-DURA4FLUSHM

OPTION LED WORK : DURA-410 + P-DURA4FLUSHM



NOT APPROVED CE



US / EU TRAILER HITCH

Ref : TZK001



BUMPER «ARB»

FRONT BUMPER ARB

- ARB ALLOY BAR
- ARB SUMMIT BAR
- ARB SAHARA BAR
- ARB COMMERCIAL BAR
- SMARTBAR (Plastic)

With or without winch support
With or without high-rider



REAR BUMPER ARB



ACCESSORIES «RANGER»



NOT APPROVED CE

SUSPENSION KIT

RANGER (2011-2018)

Ref : SK072 - Shock absorber «standard»

Ref : SK072P - Shock absorber «adjustable»

RANGER (2018+)

Ref : SK098 - Shock absorber «standard»

Ref : SK098P - Shock absorber «adjustable»

+50 MM - LOAD OF CHOICE

Front : Until 50KG or until 100KG or +100KG

Rear : Until 100KG or de until 300KG or until 500KG



SNORKEL

Ref : SFR8



Window (4 pieces) DC : SLW92431037B

Window (2 pieces) SC : SLW92231040B



DEFLECTOR

Capot : SPG012051



WING EXTENSION

Ref : FF212050-MX

DC + XC (2015-18) (5 CM)

Ref : DE-FENDER

2016+ (2 CM)



Ref : FF212050B0

DC + SC (2015+) (5 CM)

Ref : FF212050

DC + SC (2015+) (5 CM)





N4 OFF ROAD

SKID PLATES

Skid plate - Front - Alu 8 mm : *N4-BLAV53A*

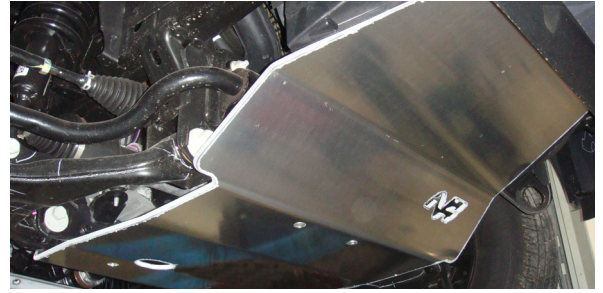

Skid plate - Gearbox - Alu 8 mm : *N4-BLBT18A*

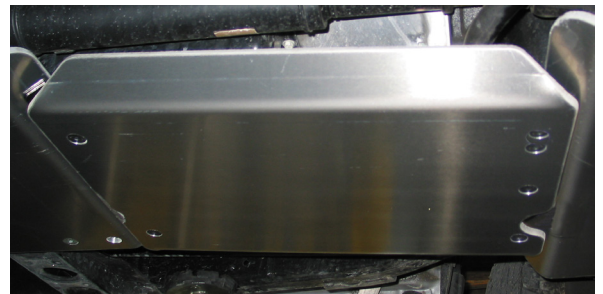

Skid plate - Transfer Box - Alu 8 mm : *N4-BLBT51A*



Skid plate - Fuel tank - Alu 6 mm - *N4-BLRE30B*



Skid plate - Adblue - Alu 6 mm - *N4-BLRE44B*

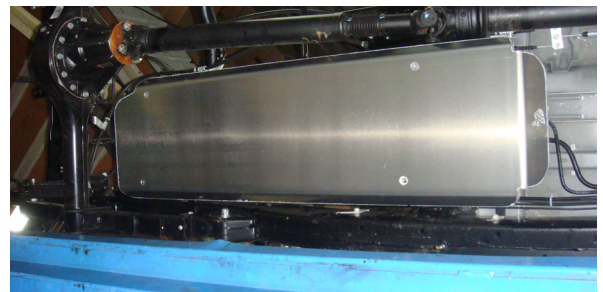

Skid plate - Rear diff - Alu 6 mm - *N4-BLDV44A*



SIDE PROTECTION RAILS ø 60 mm (Pair)

Ref : N4-MPMT002



WINCH MOUNTING

Ref : N4-KMT018

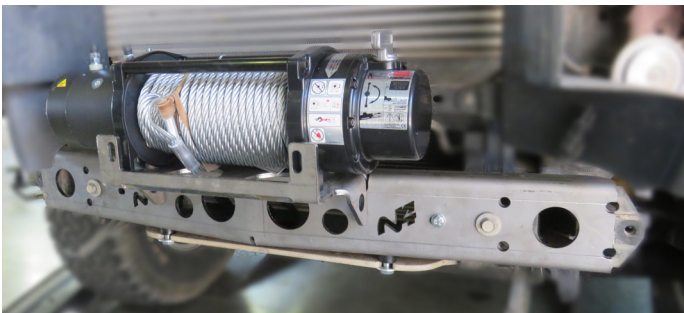

Voir Treuil page 30

PRE-FILTER MOUNTING KIT

Ref : N4-SCM0138

Allows the mounting of a RACOR FG500 pre-filter.



PRE-FILTER FG500

Ref : N4-SCM004

CARTRIDGE FG500

Ref : N4-SCM004C

REAR SHOCK ABSORBER PROTECTION

Ref : N4-SUKT37

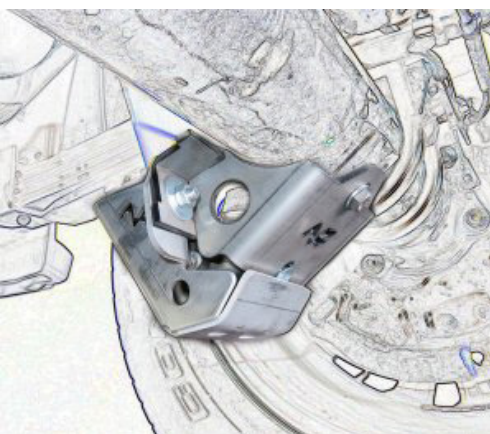



TRANSIT & RANGER RAPTOR



BULL BAR & SIDE STEP



Ford RANGER RAPTOR

FRONT PROTECTION



CE APPROVED

Sold with European homologation certificate
Standard 2005/66 / CE

SUPER BAR INOX - ø 76 mm

Ref : ECSPB470

FORD RANGER RAPTOR

ADAPTIVE RADAR & CAMERA COMPATIBLE



SUPER BAR NOIR - ø 76 mm

Ref : ECSPB470N

FORD RANGER RAPTOR

ADAPTIVE RADAR & CAMERA COMPATIBLE



Ford TRANSIT 2014+

FRONT PROTECTION



CE APPROVED

Sold with European homologation certificate
Standard 2005/66 / CE

MEDIUM BAR INOX - ø 63 mm

Inox : ECMED368

Noir : ECMED368N

FORD TRANSIT 2014+

ADAPTIVE RADAR & CAMERA COMPATIBLE



SIDE STEP

3 Pieces

Noir : ECMED368N

FORD TRANSIT 2014+ (L3)

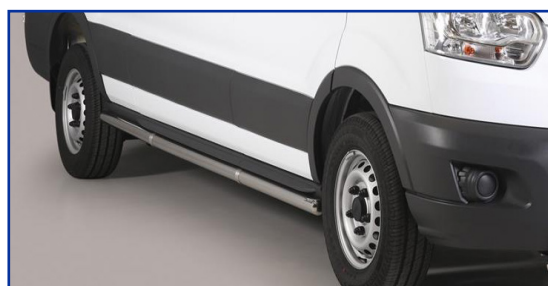



WINCH

WINCH

WARN

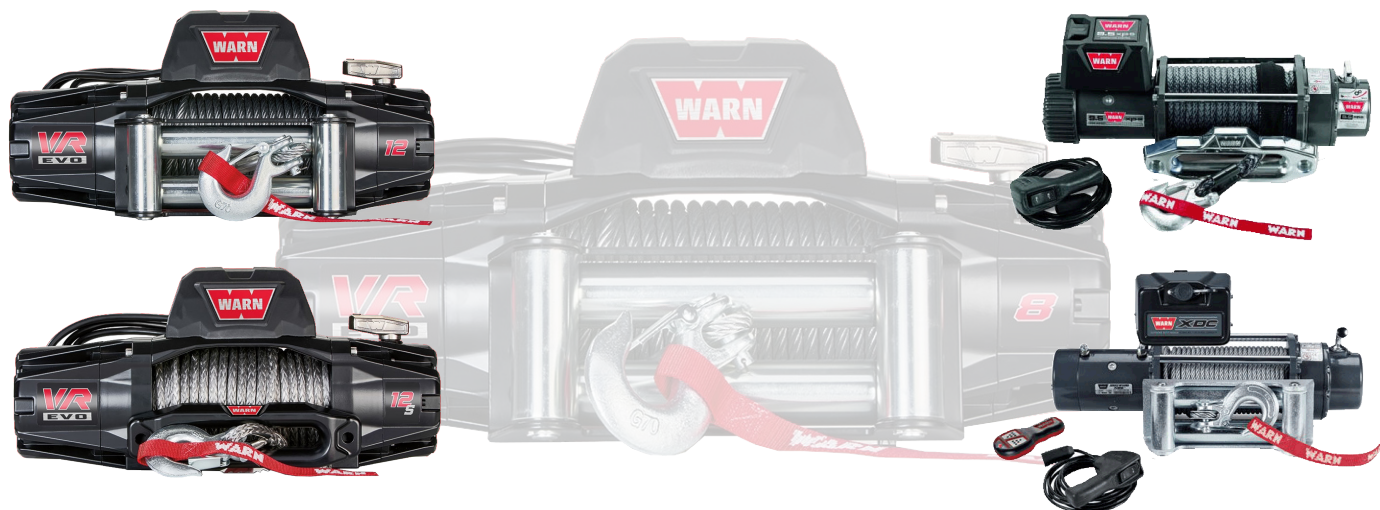

	LINE PULL	VOLTAGE	REMOTE CONTROL	ROPE	DIM RPOE	REF
VR-EVO 8	3629 KG	12 V	wired + wireless	STEEL	27,4 m x 8 mm	LIEWA103250
VR-EVO 8S	3629 KG	12 V	wired + wireless	SPYDURA	27,4 m x 9,5 mm	LIEWA103251
VR-EVO 10	4536 KG	12 V	wired + wireless	STEEL	27,4 m x 9 mm	LIEWA103252
VR-EVO 10S	4536 KG	12 V	wired + wireless	SPYDURA	27,4 m x 9,5 mm	LIEWA103253
VR-EVO 12	5443 KG	12 V	wired + wireless	STEEL	25,9 m x 9,5 mm	LIEWA103254
VR-EVO 12S	5443 KG	12 V	wired + wireless	SPYDURA	27,4 m x 9,5 mm	LIEWA103255
9.5 XP	4300 KG	12 V	wired + wireless	STEEL	30 m x 8 mm	LIEWA086500
9.5 XP-S	4300 KG	12 V	wired + wireless	SPYDURA	24 m x 9,5 mm	LIEWA088850
9.5 XDC	4300 KG	12 V	wired + wireless	STEEL	30 m x 8 mm	LIEWA074700
9.5 XDC-S	4300 KG	12 V	wired + wireless	SPYDURA	24 m x 9,5 mm	LIEWA088750

COME-UP



	LINE PULL	VOLTAGE	REMOTE CONTROL	ROPE	DIM ROP	RELAY	REF
DV-9	4000 KG	12 V	wired	STEEL	30,5 m x 8,3 mm	SEPARATE	WA-DV9
DV-12	5400 KG	12 V	wired	STEEL	38 x 9,5 mm	SEPARATE	WA-DV12
DS9,5	4300 KG	12 V	wired	STEEL	30,5 m x 8,7 mm	SEPARATE	WA-DS9,5
DS9,5I	4300 Kg	12 V	wired	STEEL	30,5 m x 8,7 mm	INTEGRATED	WA-DS9,5I
DS9,5RS	4300 KG	12 V	wired + wireless	SYNTHETIC	30,5 m x 10 mm	SEPARATE	WA-DS9,5RS
9,5RSI	4300 KG	12 V	wired + wireless	SYNTHETIC	30,5 m x 10 mm	INTEGRATED	WA-DS9,5RSI



GRILL MOUNT KIT

RANGER 2016+

GK-FR-01K	KIT + 2 x TRIPLE-R 750
GK-FR-PL-01K	KIT - 2 x TRIPLE-R 750 + PL
GK-FR-EL-01K	KIT - 2 x TRIPLE-R 750 Elite

RANGER 2019+

GK-FR-02K	KIT + 2 x TRIPLE-R 750
GK-FR-PL-02K	KIT - 2 x TRIPLE-R 750 + PL
GK-FR-EL-02K	KIT - 2 x TRIPLE-R 750 Elite

TRANSIT CUSTOM 2012+

GK-FTC-01K	KIT + 2 x TRIPLE-R 750
GK-FTC-PL-01K	KIT + 2 x TRIPLE-R 750 + PL
GK-FTC-EL-01K	KIT + 2 x TRIPLE-R 750 Elite

TRANSIT 2015+

GK-FT-01K	KIT + 2 x ST-4
-----------	----------------

TRANSIT 2018+

GK-FTC-02K	KIT + 2 x TRIPLE-R 750
GK-FTC-PL-02K	KIT + 2 x TRIPLE-R 750 + PL
GK-FTC-EL-02K	KIT + 2 x TRIPLE-R 750 Elite

COURIER 2014+

GK-FTCOUR-01K	KIT + 1 x Linear 18
GK-FTCOUR-EIi	KIT + 1 x Linear 18 Elite



LAZER

TRIPLE-R



TRIPLE-R 750



REF	00R4-STD-B
LEDS	4
POWER	45 W / 4100 Lu
SIZE	230 MM



TRIPLE-R 750 WITH PL



REF	00R4-PL-STD-B
LEDS	4
POWER	45 W / 4100 Lu
SIZE	230 MM



TRIPLE-R 750 ELITE 3



REF	00R4-E3-B
LEDS	4
POWER	45 W / 4510 Lu
SIZE	230 MM



TRIPLE-R 850



REF	00R6-STD-B
LEDS	6
POWER	66 W / 6150 Lu
SIZE	322 MM



TRIPLE-R 850 WITH PL



REF	00R6-PL-STD-B
LEDS	6
POWER	66 W / 6150 Lu
SIZE	322 MM



TRIPLE-R 850 ELITE 3



REF	00R6-E3-B
LEDS	6
POWER	66 W / 6760 Lu
SIZE	322 MM



TRIPLE-R 1000



REF	00R8-STD-B
LEDS	8
POWER	90 W / 8200 Lu
SIZE	410 MM



TRIPLE-R 1000 WITH PL



REF	00R8-PL-STD-B
LEDS	8
POWER	90 W / 8200 Lu
SIZE	410 MM



TRIPLE-R 1000 ELITE 3



REF	00R8-E3-B
LEDS	8
POWER	90 W / 9020 Lu
SIZE	410 MM



TRIPLE-R 1250 WITH PL



REF	00R12-PL-STD-B
LEDS	12
POWER	135 W / 12300 Lu
SIZE	590 MM



TRIPLE-R 1250 SMARTVIEW



REF	00R12-SV-B
LEDS	12
POWER	105 W / 12170 Lu
SIZE	590 MM



TRIPLE-R 16



REF	00R16-B
LEDS	16
POWER	180 W / 16400 Lu
SIZE	765 MM



TRIPLE-R 16 ELITE 3



REF	00R16-E3-B
LEDS	16
POWER	180 W / 18040 Lu
SIZE	765 MM



TRIPLE-R 24



REF	00R24-STD-B
LEDS	24
POWER	270 W / 24600 Lu
SIZE	1125 MM



TRIPLE-R 28



REF	00R28-STD-B
LEDS	28
POWER	315 W / 28700 Lu
SIZE	1305 MM

ST & T & UTILITY



ST2 EVOLUTION



REF	0002-EVO-B
LEDS	2
POWER	23 W / 2068 Lu
SIZE	124 MM



ST4 EVOLUTION



REF	0004-EVO-B
LEDS	4
POWER	47 W / 4136 Lu
SIZE	204 MM



ST6 EVOLUTION



REF	0006-EVO-B
LEDS	6
POWER	70 W / 6204 Lu
SIZE	284 MM



ST8 EVOLUTION



REF	0008-EVO-B
LEDS	8
POWER	95 W / 8272 Lu
SIZE	366 MM



ST12 EVOLUTION



REF	0012-EVO-B
LEDS	12
POWER	144 W / 12408 Lu
SIZE	524 MM



T16 EVOLUTION



REF	0016-EVO-B
LEDS	16
POWER	192 W / 16544 Lu
SIZE	684 MM



T24 EVOLUTION



REF	0024-EVO-B
LEDS	24
POWER	262 W / 24816 Lu
SIZE	1004 MM



T28 EVOLUTION



REF	0028-EVO-B
LEDS	28
POWER	278 W / 28952 Lu
SIZE	1164 MM

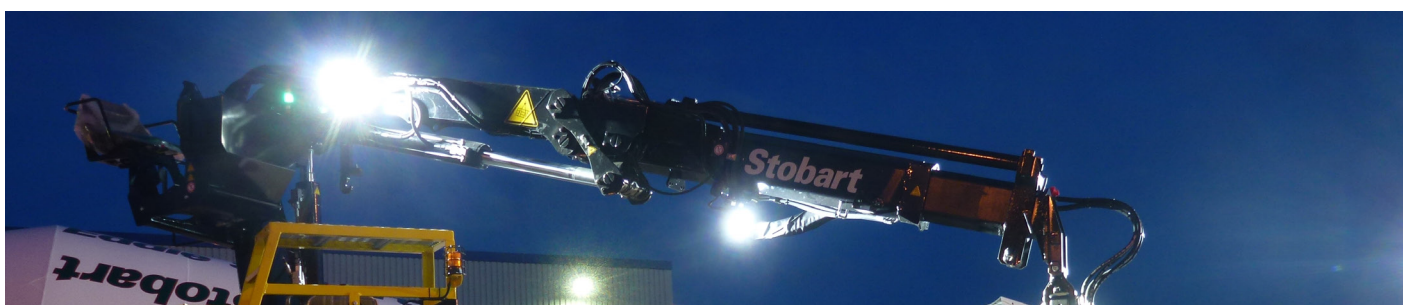

UTILITY 25



REF	00U25-B
LEDS	4
POWER	25 W / 3016 Lu
SIZE	80 X 56 X 80 MM



UTILITY 45



REF	00U45-(SLIM/WIDE*) (ADR*)
LEDS	4
POWER	45 W / 4560 Lu
SIZE	110 X 85 X 108 MM



UTILITY 80



REF	00U80-(SLIM/WIDE*) (ADR*)
LEDS	4
POWER	80 W / 8820 Lu
SIZE	110 X 85 X 108 MM



LAZER

LINEAR



LINEAR 6



REF	0L06-LNR
LEDS	6
POWER	21 W / 2250 Lu
SIZE	232 MM



LINEAR 6 ELITE



REF	0L06-LNR-EL
LEDS	6
POWER	42 W / 4050 Lu
SIZE	232 MM



LINEAR 12



REF	0L12-LNR
LEDS	12
POWER	42 W / 4500 Lu
SIZE	382 MM



LINEAR 12 ELITE



REF	0L12-LNR-EL
LEDS	12
POWER	84 W / 8100 Lu
SIZE	382 MM



LINEAR 12 ELITE + PL



REF	0L12-PL-LNR
LEDS	12
POWER	84 W / 8100 Lu
SIZE	382 MM



LINEAR 18



REF	0L18-LNR
LEDS	18
POWER	63 W / 6750 Lu
SIZE	532 MM



LINEAR 18 ELITE



REF	0L18-LNR-EL
LEDS	18
POWER	126 W / 12150 Lu
SIZE	532 MM



LINEAR 18 ELITE + PL



REF	0L18-PL-LNR
LEDS	18
POWER	126 W / 12150 Lu
SIZE	532 MM



LINEAR 24 FLOOD



REF	0L24-FL-LNR
LEDS	24
POWER	168 W / 16200 Lu
SIZE	682 MM



LINEAR 36



REF	0L36-LNR
LEDS	36
POWER	126 W / 13500 Lu
SIZE	982 MM



LINEAR 42



REF	0L42-LNR
LEDS	42
POWER	147 W / 15750 Lu
SIZE	1132 MM



LINEAR 48



REF	0L48-LNR
LEDS	48
POWER	168 W / 18000 Lu
SIZE	1282 MM



JAMES BAROUD

TENTE DE TOIT

DISCOVERY / EXTREME / SPACE



+25 KG



+30 CM



DISCOVERY

STD : 140 x 200 - JB465281
XXL : 160 x 260 - JB465283

EXTREME

STD : 140 x 200 - JB465291
XXL : 160 x 220 - JB465294

SPACE

STD : 140 x 200 - JB465285
XXL : 160 x 220 - JB465288

EVASION / EXPLORER / GRAND RAID



+25 KG



+25 KG



EVASION

STD : 140 x 200 - JB465201
XXL : 160 x 260 - JB465211

EXPLORER

STD : 140 x 200 - JB465231

GRAND RAID

STD : 160 x 200 - JB465261
XXL : 160 x 220 - JB465251

VISION



VISION 150

STD : 220 X 150 - JB465334

VISION 180

STD : 220 x 180 - JB465335





RECARO

Recaro Specialist

- S**
- » Small and medium size : short seat with flat side supports.
- M**
- » Medium and large size : long seat and extra flat cushion.
 - » Stretch seat cushion
- L**
- » Medium and large size : long seat and pronounced side supports
 - » Stretch seat cushion

Characteristics :

- » Lumbar support via a spacer
- » Adjustable backrest tilt
- » Adjustable headrest
- » Preformed backrest contours
- » Bilateral file unlocking



Options :

- » Electric backrest adjustment



Tissu Grey



Tissu Black



Tissu & leatherette Black



Alcantara & leatherette Black



Leatherette Black

Recaro Expert

- S**
- » Small and medium size : short seat with flat side supports
- M**
- » Medium and large size : long seat and extra flat cushion.
 - » Stretch seat cushion
- L**
- » Medium and large size : long seat and pronounced side supports
 - » Stretch seat cushion

Characteristics :

- » Lumbar support via a spacer
- » Adjustable headrest
- » Preformed backrest contours
- » Adjusting the side cheeks of the backrest
- » Adjustable backrest tilt
- » Bilateral file unlocking



Options :

- » Electric backrest adjustment



Tissu Grey



Tissu Black



Tissu & leatherette Black



Alcantara & leatherette Black



Leatherette Black

Recaro Sportster CS

Characteristics :



Standard

- » Performance seat
- » Race seat look
- » Harness passages for 4-point belt, also suitable for 3-point belt
- » Backrest tilt adjustment
- » Integrated headrest
- » Unlocking the backrest
- » Integrated side supports
- » Pronounced side supports (Sportster CS)

CS

Options :

- » Universal side airbag
- » 2 heating positions

- » + Easy access: easier getting in and out of the vehicle
- » + Seat cushion with flat side supports

Without heating

With heating



Tissu Grey



Leatherette Black



Alcantara & leatherette Black



Black leather



Alcantara white & leatherette Black



Alcantara red & leatherette Black



Standard

- » Lumbar support
- » Stretch seat cushion
- » Electric height adjustment
- » Intuitive control panel
- » Bilateral file unlocking
- » Adjustable headrest
- » File Chaplain

Ergomed E

- » + Manual backrest adjustment
- » + Adjustable seat tilt

Ergomed ES

- » + Electropneumatic side cheeks on the seat and back
- » + Electric adjustment of the seat tilt
- » + Electric backrest tilt adjustment
- » + RECARO Climate Pack

Ergomed ES



Tissu Grey



Tissu Black



Tissu Black & leatherette Black



Alcantara & black leather



Black leather



Mesh & black leather

Ergomed E

Recaro Ergomed

Characteristics :





RECARO

Recaro Orthopad

Standard

- » RECARO climate pack (seat ventilation and heating)
- » Adjustable backrest side cheeks
- » Pneumatic lumbar support
- » Stretch seat cushion
- » Intuitive control panel
- » Individually adjustable shoulder support
- » Adjustable electric backrest Adjustable headrest
- » Adjustable headrest
- » Bilateral file unlocking
- » Contour of preformed backrest



Tissu Grey



Tissu Black



Tissu &
Black leather



Black leather



Alcantara &
leatherette
Black

Anatomic Design



Support Lominaire



Option Heater



Option Ventilation



Easy Access



Composites lightweight



Certified road / TUV



Option Airbag



RECARO



+32(0)71/66.92.33 - info@eurojapan.be - www.eurojapan.be - Rue saint Jean 23, 5600 neuville (philippeville)

* Attention, les prix indiqués dans le catalogue peuvent être changé à tout moment par le vendeur sans avis préalable. Nous ne pouvons pas être tenus responsables de ces changements !
 * Opgelet, de geïndiceerde prijzen en gegevens in onze catalogoog zijn onder voorbehoud van wijzigingen . Wij kunnen niet verantwoordelijk worden gesteld voor deze aanpassingen !
 * Please note that the prices and information in this catalogue, is subject to change whitout prior notice. We can not be held liable for these changes !